



3D IMAGING

PRO▶VECTA® 3D Prime

AN ALL AROUND PERFECT PICTURE.
3D and 2D X-ray images with
exceptional image quality.

 Made
in
Germany

 50 YEARS
Over
X-RAY TECHNOLOGY

 AIR
TECHNIQUES equipped for life®

Taking diagnostics to the next level

ProVecta 3D Prime combines diagnostic flexibility, ease of use and high efficiency



Key Features

- 3D and 2D images from one unit
- Anatomically adapted jaw-shaped 3D image includes all dentition, including third molar area
- 50 x 50 mm volumes in 80 or 120 μm resolution
- High resolution CsI flat panel sensor creates brilliant high quality 3D and 2D images
- Efficient radiation dose thanks to the anatomically adapted volume and sensor technology
- Great quality with lower dose in standard (SQ) mode
- Metal artifact reduction
- Intuitive 7" touchscreen
- Maximize workflow: fast scan and volume rendering
- Includes VisionX Imaging software: an all-in-one, easy-to-use imaging software suite. Implant planning visualization included. Advanced planning and additional modules optional.



Ideal imaging volumes, easy positioning, high image quality: The new ProVecta 3D Prime represents a milestone in the field of 3D X-ray systems. Thanks to our proprietary technology, the 3D images generated by the ProVecta 3D Prime captures the entire patient dentition, including the third molar region and excludes extraneous anatomy. In 2D mode, the ProVecta 3D Prime uses a high resolution CsI flat panel sensor to generate exceptional quality 2D panoramic images.

3D Diagnostics: The Key Indicators

Be confident in your diagnosis and confirm your treatment plan.

Tooth development	<ul style="list-style-type: none"> ▪ Hyperplasia or dysplasia ▪ Over-retained or impacted teeth
Fractures	<ul style="list-style-type: none"> ▪ Root or jaw fractures
Implant technology	<ul style="list-style-type: none"> ▪ Augmentation/bone formation ▪ Implant visualization included with implant libraries ▪ DICOM files export ▪ Uncover or confirm complications
Endodontics	<ul style="list-style-type: none"> ▪ Periapical examinations ▪ Complex anomalies of the root canal system ▪ Endodontic instrument fractures
Foreign bodies	<ul style="list-style-type: none"> ▪ Suspected perforation, in particular pin perforation ▪ Localisation of foreign bodies in the mouth and jaw area
Salivary stones	<ul style="list-style-type: none"> ▪ Diagnose salivary stones
Pathological changes	<ul style="list-style-type: none"> ▪ Maxillary sinus area ▪ Cysts and odontogenic tumors

See only what you need to see

ProVecta 3D Prime offers an ideal 3D volume that is adapted to the shape of the jaw

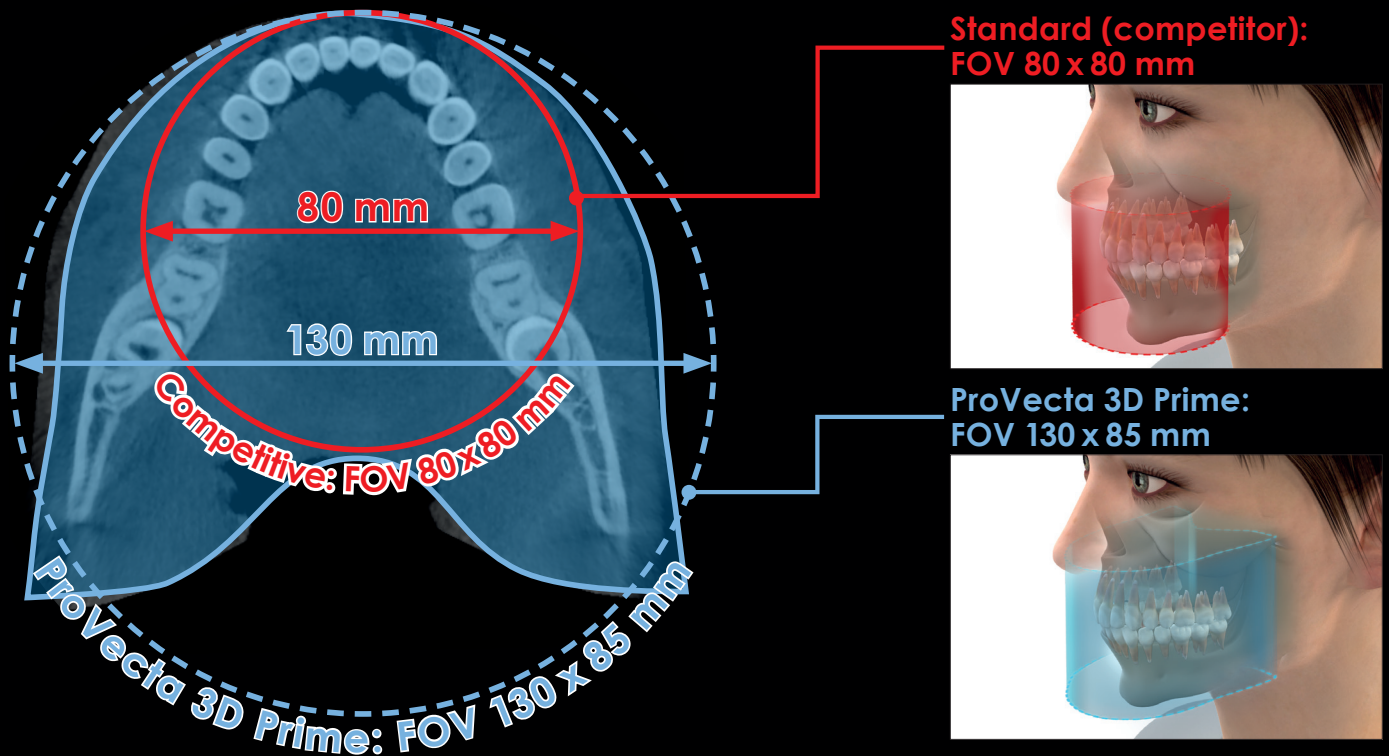

Get more

The ProVecta 3D Prime generates a unique 130mm x 85mm equivalent jaw-shaped anatomically adapted volume that encompasses all treatment areas without imaging non-relevant anatomy.

A tightly collimated cone beam, highly sensitive CsI flat panel sensor and a fast scan minimizes dosage while providing excellent image quality. The ProVecta 3D Prime reconstruction algorithms allow 3D volumes to be rendered and displayed in the shortest time possible to maximize clinical workflow.



ProVecta 3D Prime: FOV 50 x 50 mm

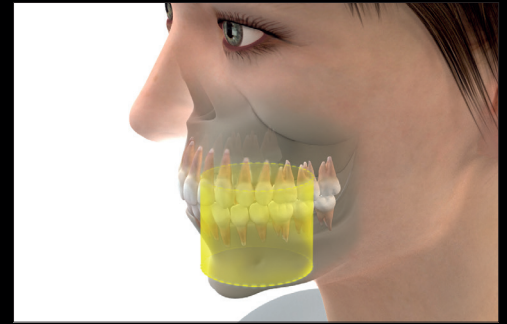
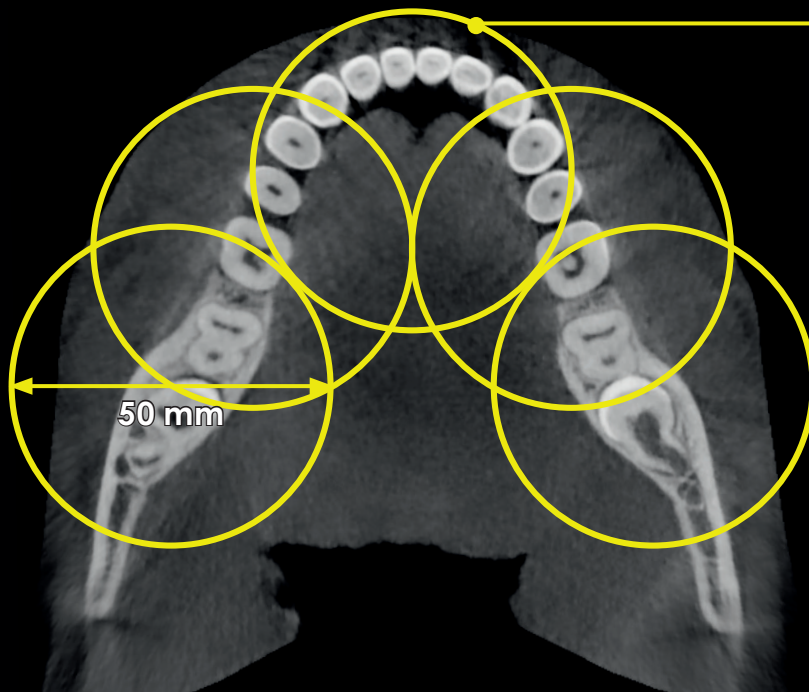

Additional volumes 50 x 50 mm

In addition to the standard adult 130 x 85 volume, the ProVecta 3D Prime offers child size* and ten additional 50 x 50 volumes: five each for the upper jaw and for the lower jaw. Indications include endodontic and implant procedures. Within the smaller 50 x 50 volume, the resolution can be specified at either 80 or 120 microns to further increase clarity and accuracy.

1,020 patients were examined in a study from Dr Johannes Krause**. The study shows that a volume with a height of 85 mm and diameter of 110 mm is required for 100% coverage of the dental region. With a volume of e.g. 80 x 80 mm, this means that only around 1.4% of all patients can be covered in full. By contrast, the adapted, jaw-shaped volume of the ProVecta 3D Prime covers the dental region of all patients.*

SQ mode

SQ (Standard Quality) mode provides the option of accurate and clear images with a reduced dose compared to HQ (High Quality) mode. SQ Mode balances image quality and dosage for many clinical applications including implant planning and location of impacted or supernumerary teeth.

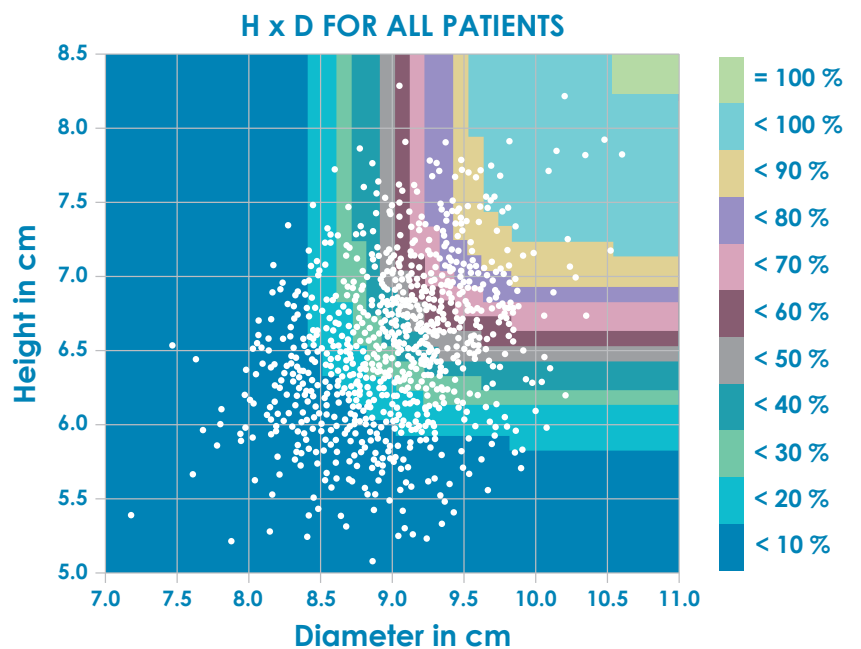

*For pediatric patients from 7 years on.

**Source and graphic bottom right: Dissertation conclusions, Dr Johannes Krause, Charité – Universitätsmedizin Berlin, 'Investigations into the required field of view for imaging 3D diagnostics in dental medicine', 1 January 2013

2D images with exceptional image quality

ProVecta 3D Prime is the ultimate in imaging flexibility. In addition to a full featured 3D imaging system, ProVecta 3D Prime provides brilliant 2D panoramic images that set the standard for extraoral imaging. With an incredibly short panoramic scan time of 7 seconds, ProVecta 3D Prime will maximize your clinical workflow.



Key Features

- S-Pan technology for easier diagnostics
- CsI sensor for improved image quality and reduced radiation exposure
- Extremely fast: OPG images in 7 seconds
- Tolerant of typical positioning errors –thanks to the S-Pan technology

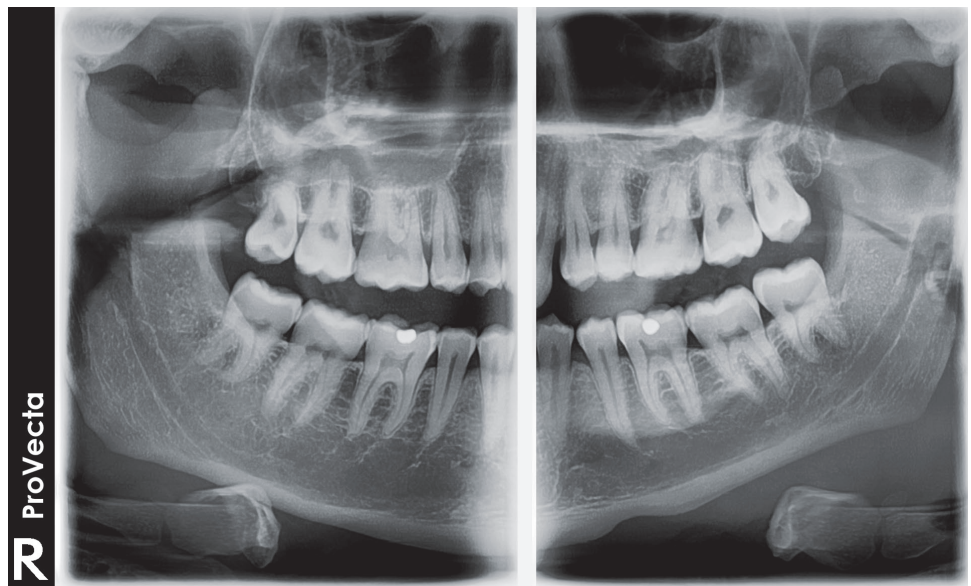

Panoramic X-ray programs

With a total of 17 X-ray programs, ProVecta 3D Prime integrates an advanced 2D panoramic X-ray system for all your imaging requirements, including:

- Right, left and frontal collimated libraries
- 4 pediatric programs: An imaging mode with smaller exposure area; a reduction in the dose without any loss of diagnostic information
- 4 Bitewing programs and orthogonal dentition
- 2 programs for temporomandibular imaging (functional diagnosis)
- 2 programs for sinus X-ray images to display paranasal sinuses

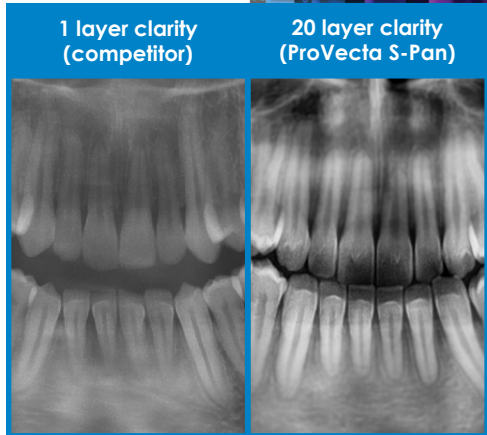
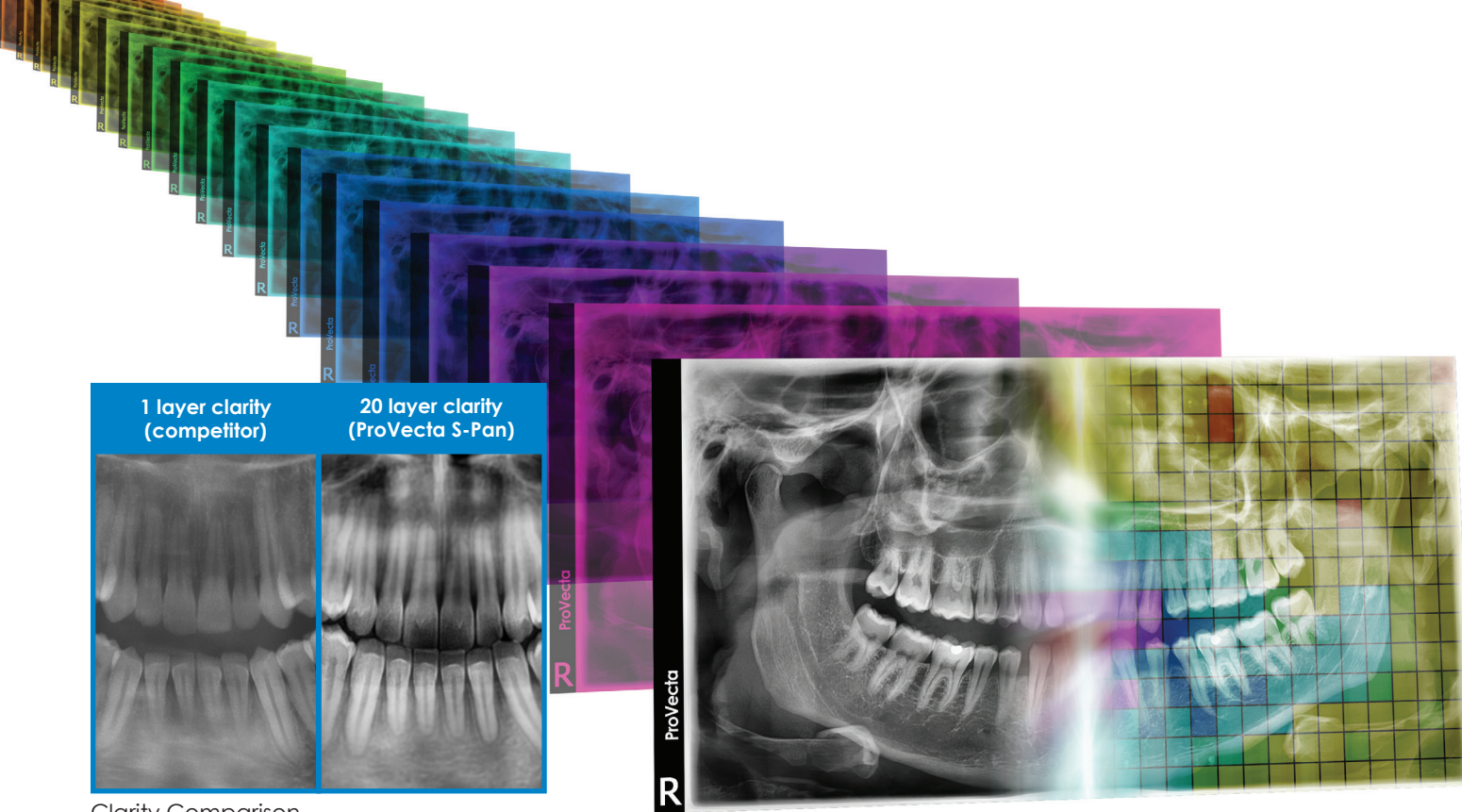

Clarity Comparison

S-Pan technology: Extremely sharp images to maximize your diagnostic capabilities

With S-Pan technology, multiple images are taken, and each of those images are further segmented. S-Pan technology then automatically selects the best segments and compiles them into one optimized panoramic image. The result is a new standard in 2D image clarity and sharpness.



Intuitive touchscreen: All functions at your fingertips

The innovative 7" touchscreen provides clear text and symbols to guide you through all functions while the patient is in front of you. This ensures correct patient positioning and fewer retakes.

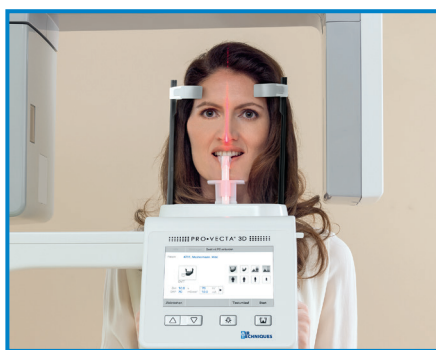

Simple face-to-face patient positioning

Triple laser alignment for 2D scans, and double laser alignment for 3D scans simplifies patient positioning and speeds up overall imaging time.



Efficient design minimizes space requirements

The efficient and modern design makes it easy to fit into a variety of existing spaces.

VisionX is an advanced easy-to-use all-in-one imaging software

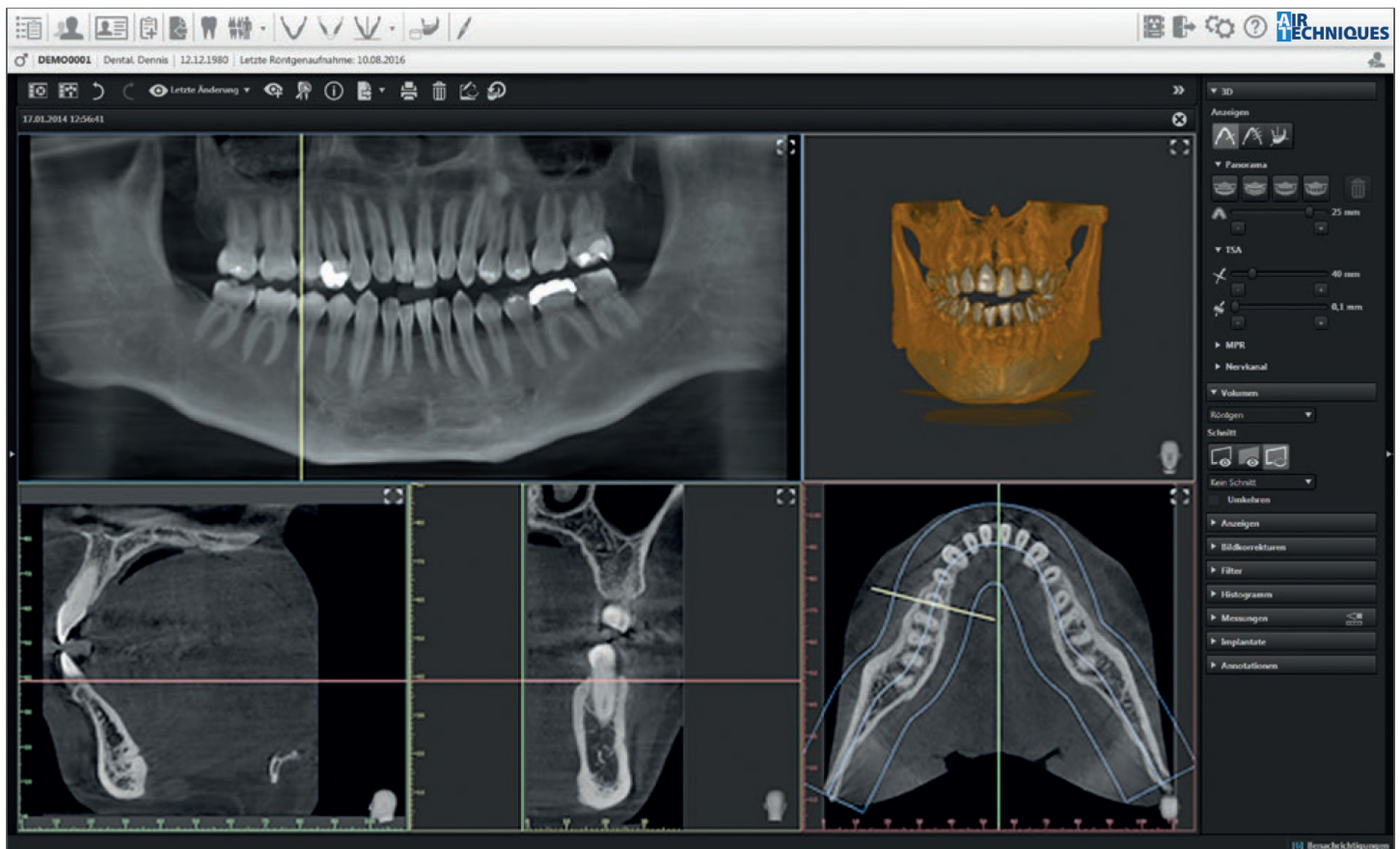

Panoramic View shows automated panoramic reconstruction

Network capable, with intuitive operation: VisionX is an efficient, intuitive full featured imaging software for the acquisition, display and editing of digital images. For reliable diagnostic images can also be edited with preset filters for further assistance with the diagnosis. The software supports DICOM data. VisionX has been optimized: it is easy to use and it maximizes practice workflow. With support for all digital image file types, VisionX can be implemented as the "go to" imaging software for your practice.

Easy one click image orientation makes navigating complex 3D images simple.

Implant planning visualization and implant libraries included. Advanced planning and additional modules optional.

The standard view includes an automatically rendered 2D Panoramic view. All three views are one click away.

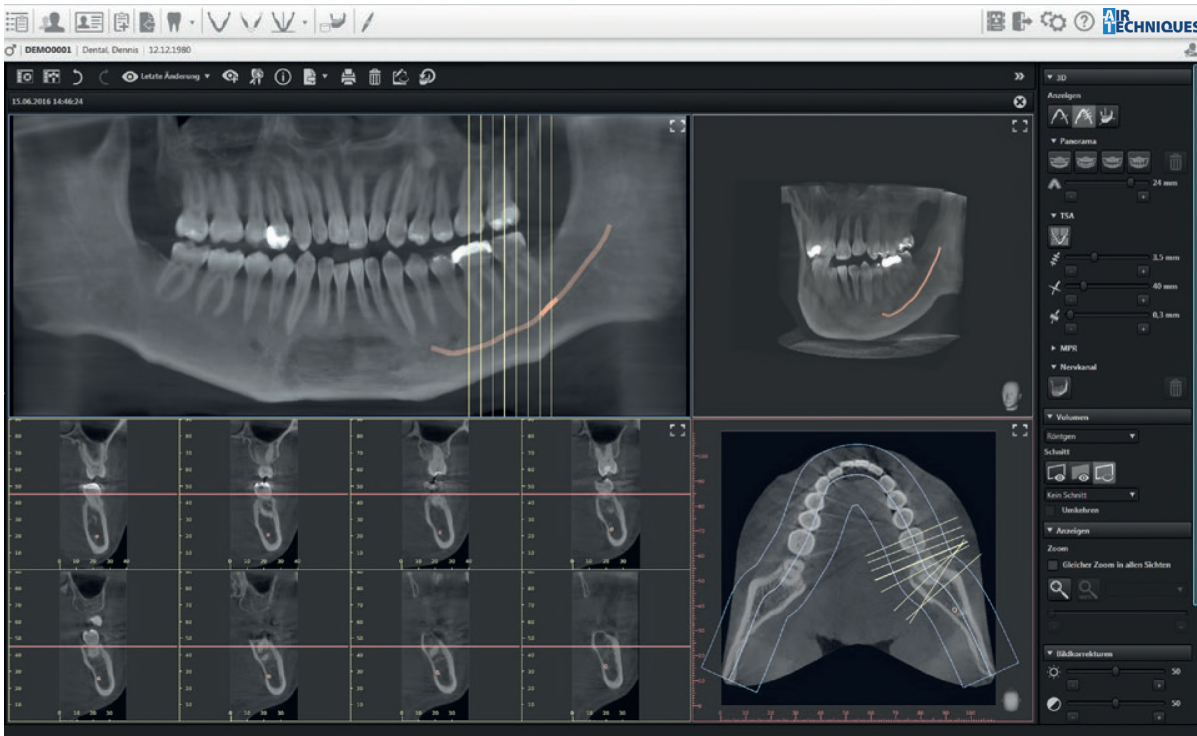

VisionX allows easy tracing of the inferior alveolar nerve canal using the transversal layer image view (TSA View).

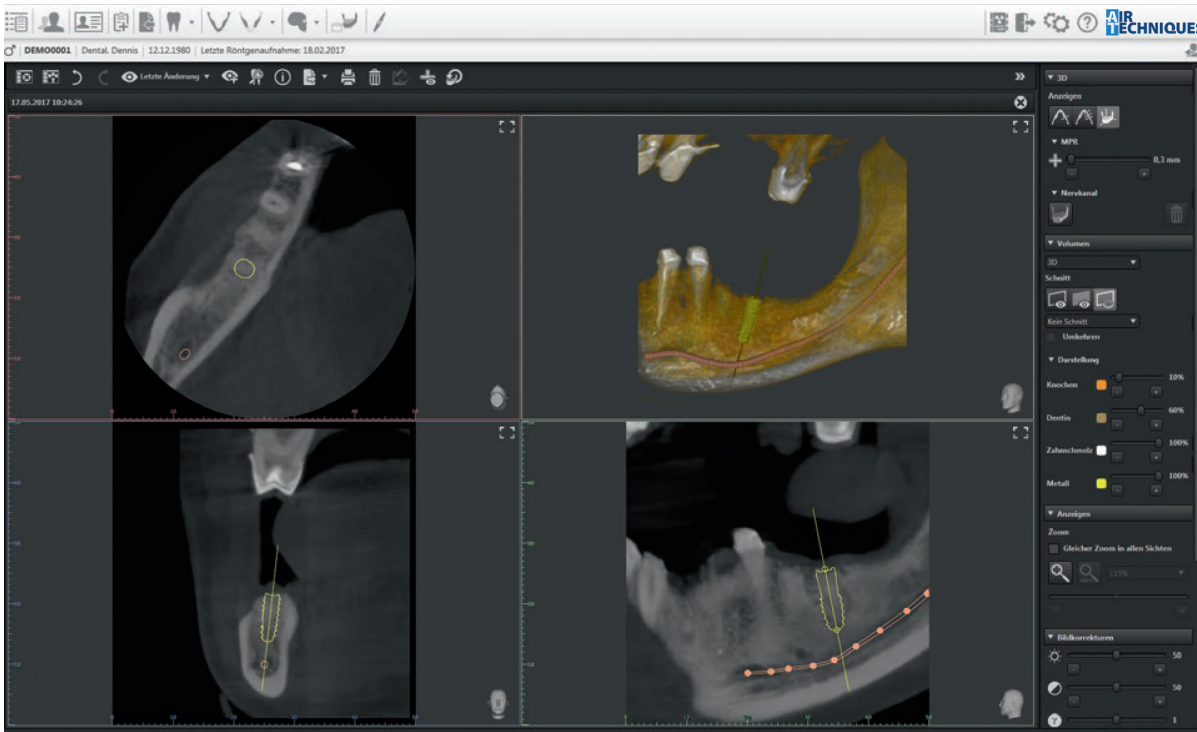

Implant planning with a 5 x 5 volume image. Shown here in the MPR view.

VisionX: features and clinical applications

- Three different 3D views (Panoramic, TSA, MPR)
- Easy to draw the nerve channel into the image
- Easy measurements in the 3D volume
- Implant visualization
- Export of 3D DICOM data

Figures, data and facts at a glance

PRO▶VECTA® 3D Prime

X-ray HV Generator

Voltage, current	50–99 kV, 4–16 mA
Rated power	1.6 kW (For 1 Second) 170W (Continuous)

Tube

Focal spot size	0.5 mm (IEC60336)
Total filtration	2.8 mm AL (at 50kV)

Image Detector

Type	CsI CMOS photodiode array
Pixel size	49.5 µm
Active sensor surface	135.8 x 36.4 mm

Scan Times

Scan times	From 2 to 18 secs.
------------	--------------------

Panoramic programs

Panoramic image	17
Image capture programs for children	4

Magnification factor

2D images	1.26
-----------	------

3D volumes

130 x 85 mm diagnostic
130 x 70 mm diagnostic
50 x 50 mm

Device dimensions

Height	55½" (1406mm)x 88½" (2250mm)
Weight	396 lbs
Height adjustment range	33"
Width x Depth	47¾" (1212mm) x 61" (1545mm)
Installation	Wall mounting

Electrical connections

Mains voltage	200 – 240 V AC
Frequency	50/60 Hz
Rated power	2.2 kVA

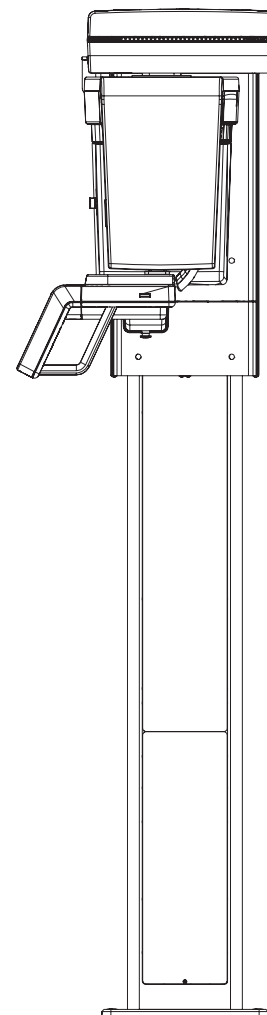
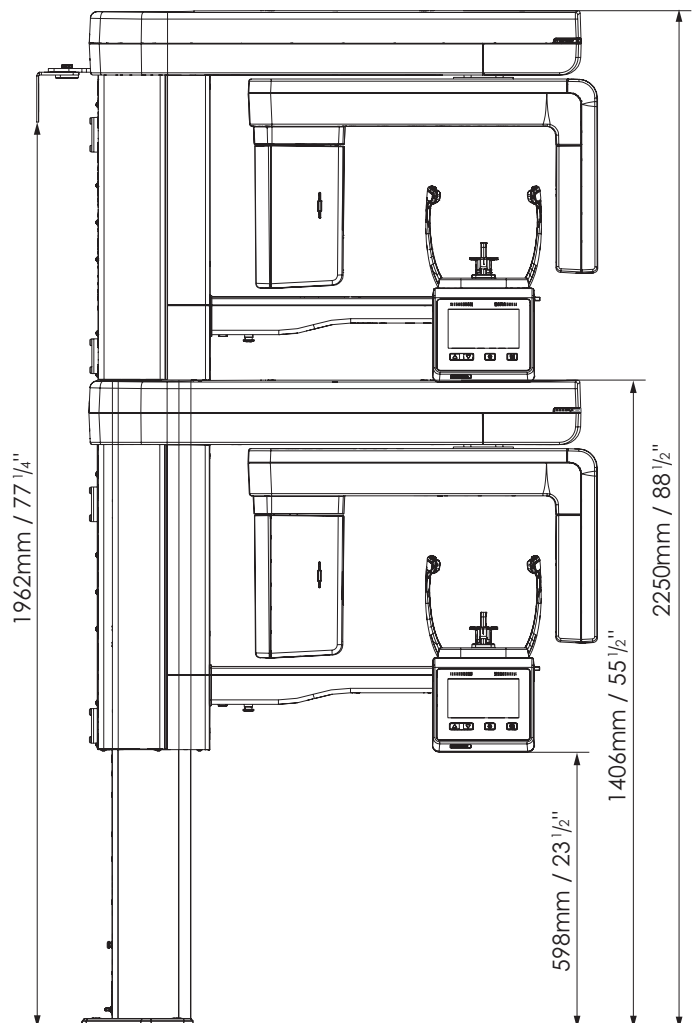

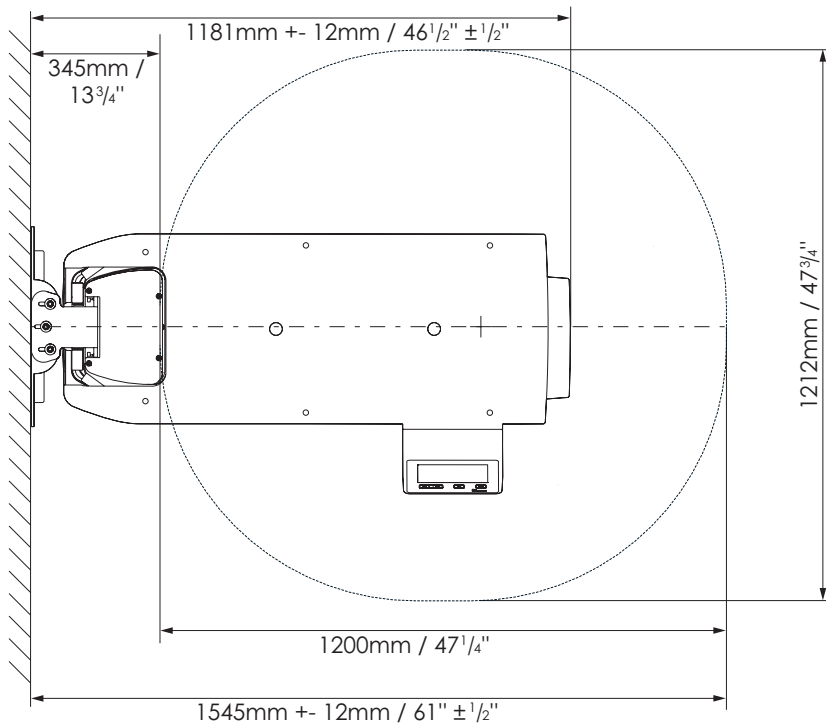



airtechniques.com

DIGITAL IMAGING WITHOUT LIMITS FROM AIR TECHNIQUES



CORPORATE HEADQUARTERS
1295 Walt Whitman Road
Melville, New York 11747-3062
800-247-8324
PN 9922-560 Rev. C



AIR
TECHNIQUES equipped for life®