



3D-PRINTING
CONE BEAM
DENTAL IMAGING

Award-Winning, Industry-Trusted Cone Beam 3D Imaging



A FLEXIBLE, UPGRADABLE 3D SOLUTION THAT HELPS YOUR PRACTICE GROW

Whether you want to expand your implant, airway and TMJ services, transition into diagnoses and treatments, or simply become more competitive with other practitioners in your area, advanced imaging is fast becoming essential to for all patient diagnoses and treatment. The i-CAT FLX V-Series cone beam 3D imaging product family offers flexible solutions with a uniquely upgradable system that maximize your practice growth.

Providing optimal clarity, ease-of-use and control, the i-CAT FLX system's field-of-view can now be upgraded based on the types of procedures your practice performs. This flexibility can revolutionize your practice by enabling more precise diagnoses and better surgical predictability. It's easier to present and obtain approval for treatment plans and procedures when patients can see what you see, chairside.

i-CAT FLX technology is especially beneficial for implants, restorations, oral and maxillofacial surgery, orthodontics, periodontics, endodontics, and TMJ and airway analysis. Invest with confidence in technology that helps your practice grow.

Better imaging + better diagnoses + better treatment = better care and practice growth.



WHY i-CAT?

Let us show you...

MOST TRUSTED 3D BRAND	1
AWARD-WINNING PERFORMANCE	2
THE i-CAT PHILOSOPHY	4
<i>SCAN</i>	5
<i>PLAN</i>	7
<i>TREAT</i>	9
EFFICIENT WORKFLOW	11
FLEXIBILITY AND CONTROL	12
SPECIALTIES	13
<i>ORTHODONTICS</i>	13
<i>IMPLANTS</i>	17
<i>ORAL & MAXILLOFACIAL SURGERY</i>	19
<i>AIRWAY ANALYSIS</i>	21
<i>PERIODONTICS</i>	23
<i>ENDODONTICS</i>	25
<i>TMJ</i>	27
i-CAT FLX V-SERIES PRODUCT	29
TECHNICAL SPECIFICATIONS	31
3D EDUCATION	32

i-CAT™

THE MOST COMPREHENSIVE 3D TREATMENT SOLUTION FROM THE MOST TRUSTED 3D IMAGING BRAND

i-CAT Solutions Have Been Installed in More than 6,500 Sites Around the World

i-CAT owners have access to highly specialized service and support, as well as continuing education. We are dedicated to helping dentists and specialists use the latest in cone beam technology.

The 3D Experts

Recognized as innovators in cone beam technology, i-CAT provides unparalleled, highly specialized service and support that can only come through a dedicated 3D focus.

As part of the i-CAT community, you have exclusive access to unprecedented educational programs, the vast knowledge of a global community of clinicians, and a world of support with our far-reaching, geographically convenient technical response team.



TELEPHONE SUPPORT



REMOTE ASSISTANCE



ACCESS TO 3D EDUCATION AND TRAINING



RESPONSIVE FIELD SERVICE AND PRODUCT SPECIALIST TEAMS ACROSS THE US AND CANADA

AWARD-WINNING PERFORMANCE

Praised by Owners, Esteemed Educational Organizations, and the Dental Community-at-Large



Voted **Best Cone Beam CT Scanner**



“ *i-CAT FLX was recognized as a winner in the very competitive imaging category this year, by addressing an issue of great importance to the panel...lowering radiation dosage to the patient.* The i-CAT FLX combines this with the other important aspect of 3D imaging – image quality. Practices dedicated to implants, restorations, oral and maxillofacial surgery, orthodontics, TMD, and airway disorders can all benefit from the flexible 3D planning and treatment tools that are integral to this comprehensive system.* ”

– **Lou Shuman, DMD, CAGS**

President and CEO of
Cellerant Consulting

Best of Class Founder
and President of Pride Institute



THE i-CAT PHILOSOPHY



Combining highly precise, cone beam 3D technology with procedure-based upgradable fields-of-view, software and flexible planning and treatment tools, i-CAT FLX V-Series offers a full suite of solutions to meet your practice's needs. As the first upgradable dedicated CBCT unit, the V-Series can easily grow as your practice needs to expand with the easily upgradable field of view. You can care for your patients with greater confidence and control than ever before.



SCAN

Clinical Control and Optimized Patient Care

With i-CAT, there's no need to compromise between image quality and patient safety. High-resolution, volumetric images provide complete 3D views for more thorough analysis of bone structure and tooth orientation, while flexible scanning options allow you to control the dose and follow ALARA (As Low As Reasonably Achievable) radiation protocols.



PLAN

Powerful, Comprehensive Treatment Tools

More than just a scanner, i-CAT includes powerful, yet easy-to-use, planning and treatment tools to help you take charge of your practice. Designed to streamline your workflow, i-CAT helps you move from scanning to consultation and treatment planning in less than 90 seconds.



TREAT⁺

More Advanced Procedures with Greater Predictability

Start planning immediately and offer an effective course of treatment — from implants to surgical guides and restorations. i-CAT's open software architecture seamlessly integrates with orthodontic systems, CAD/CAM programs, imaging software, and practice management programs, expanding your practice's capabilities.



SCAN

Flexibility and Ease

- Full dentition 3D imaging at a dose comparable to a 2D Panoramic X-ray with **QuickScan+***
- **PureScan™** advanced image technology delivers i-CAT's clearest 3D and 2D images.
- Easy-to-follow, guided workflow right at your fingertips with the **SmartScan STUDIO™** touchscreen interface for greater speed and efficiency
- Capture traditional 2D panoramic images with the **i-PAN™** feature when 3D diagnostic information is not required
- **Ergonomic Stability System (ESS)** allows for easy, seated patient positioning, designed to minimize patient movement and avoid unnecessary retakes and radiation

*i-CAT FLX V-Series offers **flexible imaging control**, allowing you to focus on each patient's unique features while **minimizing the radiation dose**.**



SmartScan STUDIO

i-CAT's SmartScan STUDIO provides an easy, customizable solution for a guided, controlled workflow in your practice. With its easy-to-use, touchscreen interface and integrated acquisition system, SmartScan STUDIO offers step-by-step guidance, allowing you to select the appropriate scan for your patient a radiation dose consistent with the ALARA (As Low As Reasonably Achievable) principle.



QuickScan+ cuts dose and scan time to just 4.8 seconds, producing a full 3D dentition at a radiation dose comparable to a panoramic image. And with rapid reconstruction rates, you are able to view in less than 30 seconds.*



PLAN

*Tx STUDIO™ is an integral part of the fast i-CAT FLX V-Series workflow and provides the power of multiple software systems combined into **one simple-to-use solution.***

Optimized Treatment Planning Software

Designed exclusively for i-CAT with Anatomage, Tx STUDIO leverages the best in anatomy imaging software and cone beam 3D technology. Software designed for a 3D system that enhances the efficiency of your practice by providing immediate access to integrated treatment tools for implant planning, surgical guides, and other applications. Using the i-CAT FLX V-Series, practitioners now have the ability to select the field-of-view sizes that best support the procedures performed. This allows all types of dental professionals to take advantage of the i-CAT FLX technology, at a price point that best supports their own particular needs. If, over time, procedures requiring larger fields-of-view are necessary, i-CAT FLX V-Series owners will have the opportunity to upgrade to the next level instead of replacing their entire cone beam solution.

Tx STUDIO has specific system requirements that need to be met prior to a successful installation.

Tx STUDIO™

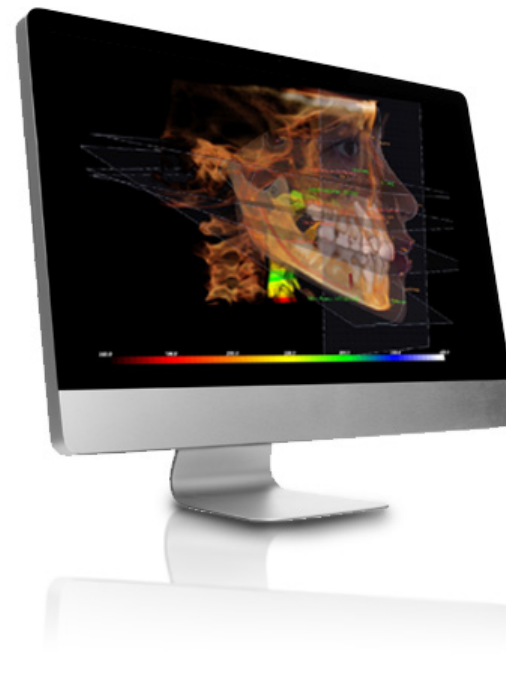

**MAC + WINDOWS
COMPATIBLE**

Open Software Architecture

i-CAT's open software architecture seamlessly integrates with orthodontic programs, CAD/CAM systems, imaging software, and practice management programs, expanding your practice's capabilities.



Surgical Guides

Expand implant-planning capabilities with a fast scan workflow and unique open software architecture, which make i-CAT universally compatible with all leading surgical guide providers. Perform treatments with more confidence and efficiency — and fewer complications — with surgical guides ordered through Anatomage service.

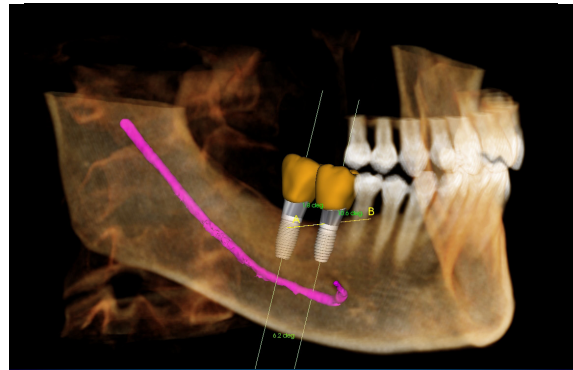

Implant Planning

Measure bone density and plan implants, abutments, and restorations simultaneously within a 3D volume or a panoramic view. Avoid potential surgical complications by checking for root entanglement prior to extractions with automatic nerve canal tracing.

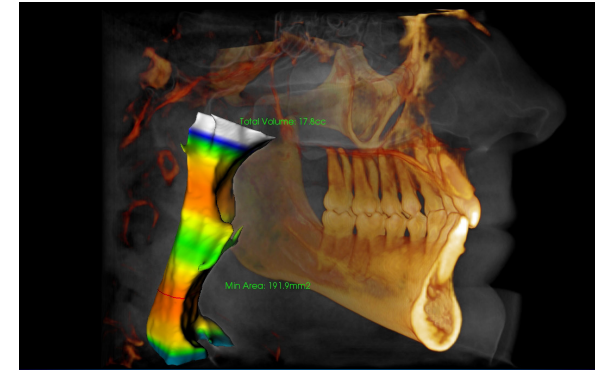

Airway Analysis

Automatically compute the total airway volume, and view segmented areas of constriction to aid in the treatment planning of obstructive sleep apnea and other airway disorders.



i-PAN

The i-PAN feature allows you to take a quick 2D pan using the same high quality sensor that is used to acquire 3D scans. Software improvements enhance overall 2D image quality.

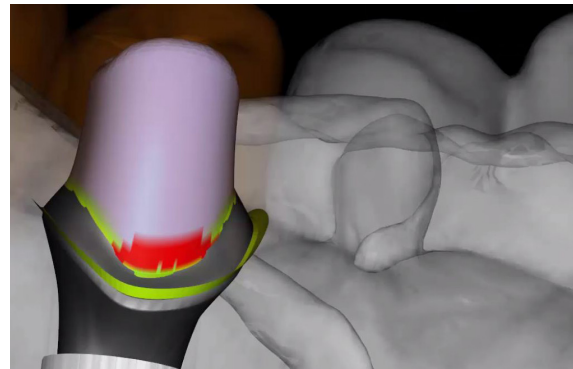

STL File Export

Simply export STL files from Tx STUDIO software so your lab can create the final restoration based on your exact design. These files also work with a wide variety of CAD/CAM and 3D-printing systems.

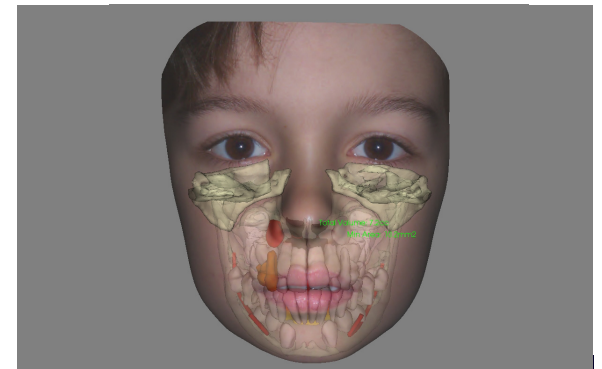

Face Matching

Bring your 3D scan data to life by superimposing a digital photograph of your patients on their scan data with face-MATCH™.



TREAT[†]

Make Your Plan a Treatment Reality

Treatment plans are done chairside or in consultation rooms in minutes with the i-CAT FLX V-Series, increasing patient engagement and interest in their treatment. When developing treatment plans, you can take full advantage of CAD/CAM technology, which expands your opportunities to meet the increasing demand for high-tech treatment. With the information provided by powerful 3D scans, you can confidently perform procedures knowing that your plan is in the best interests of your patients. Prior planning helps eliminate unseen surprises, allowing you to complete complex procedures quickly and with greater accuracy.

i-CAT is particularly beneficial for cases involving:

- Orthodontics
- Implants
- Oral & Maxillofacial Surgery
- Periodontics
- Endodontics
- TMJ
- Airway Analysis

With the assistance of the i-CAT FLX V-Series, a clinician can identify a plan for an effective course of treatment for a wide range of advanced procedures.

Patient Engagement & Communication

Designed by clinicians for clinicians, our fully integrated software allows you to develop — and communicate — your treatment plan with confidence. Full 3D visualization engages patients with compelling views and helps them understand their treatment options, which can lead to greater case acceptance.

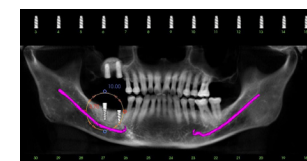
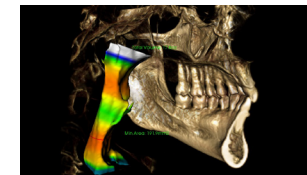



EFFICIENT WORKFLOW

Deliver Treatment Plans in Minutes and Increase Office Efficiency

SELECT
A PATIENT

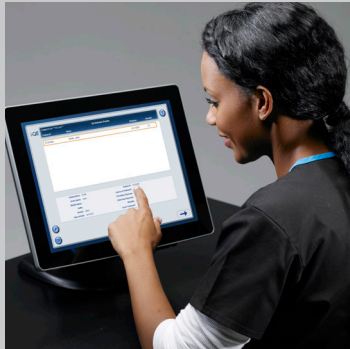

SELECT
SCAN WITH
QUICKPICKS

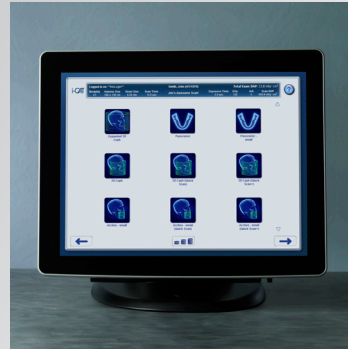

FAST
4.8 SECOND
SCAN



TYPICAL
RECONSTRUCTION
IN UNDER
30 SECONDS



*Less than 90 seconds
from scan to plan*

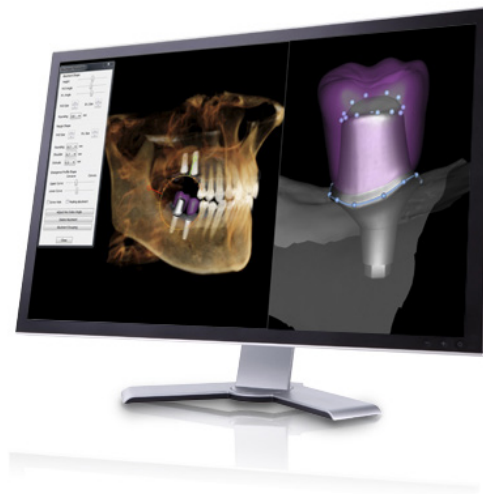

i-CAT understands that time is a valuable commodity in the dental office. Our comprehensive 3D imaging solution provides the fastest scan to plan workflow. A full ceph-height 3D scan can be obtained in as little as 4.8 seconds, and even complex treatment plans can be completed in a few minutes with the Tx STUDIO software — keeping the office moving quickly while offering excellent care.

FLEXIBILITY AND CONTROL

Clinically Driven Image and Exposure Control

Offering the most flexible imaging control of any cone beam 3D unit, i-CAT FLX V-Series allows you to target the desired field-of-view on each patient while minimizing the radiation dose.

i-CAT FLX V-Series has unique, widely adjustable 3D fields-of-view through collimation. Once your practice has selected the solution that best fits the procedures provided, the V8, V10, or V17, customizable fields of view allow you to select views from single-arch, to both arches, the condyles, and up to a full cephalometric height, for the most flexibility of treating patients according to their individual needs. Not only does i-CAT FLX V-Series provide a myriad of 3D scan sizes, it also offers flexibility in modality with i-PAN, the traditional 2D panoramic option.

The new SmartScan STUDIO touchscreen workflow allows you to choose from preset scan options of the field-of-view, dose, and resolution. Customize your own presets — or Quickpicks™ — for simple and fast scanning.

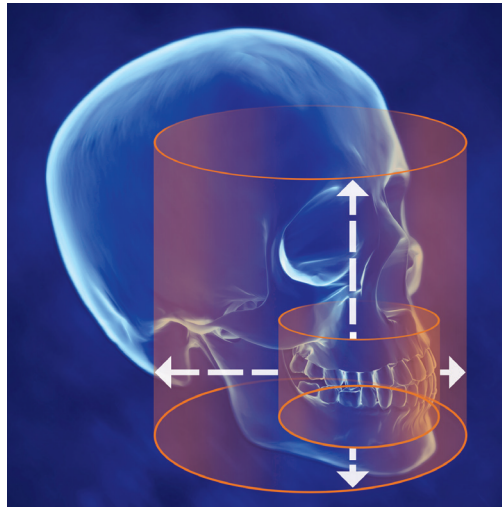

Workflow the Way You Want It

Adding to i-CAT's flexibility, you are free to choose from a wide variety of third party programs and technologies to help accomplish tasks such as CAD/CAM for digital models, restorations, robotic archwires, and more.

Pair your digital impression system with CBCT scan data

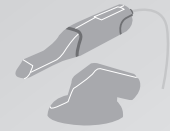

STUDIO

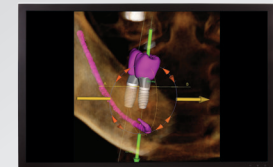

Mill chairside, or have your lab create your restorations



ORTHODONTICS



Optimize Treatment Plans with Greater Accuracy and Better Clinical Tools

Understand exact tooth position and the relationship of anatomy so you can map the most effective — and least invasive — treatment plan for the best possible alignment. Correct root angulations and find supernumerary teeth and their exact locations to enhance communication with oral surgeons — and prevent exploratory surgery. Additional treatment modules, including 3D cephalometric analysis, virtual studies, and impressionless models, make planning even more powerful.

Capture all initial records in a single, low-dose scan in just 4.8 seconds. Use Tx STUDIO 3D views to analyze teeth, roots, TMJ, airway, and sinuses without magnification or distortion. Enhance practice efficiency by capturing a complete workup in less than 10 seconds.

“ The i-CAT FLX is an invaluable tool to diagnose, educate, and treat patients. The i-CAT FLX has consistently helped me to achieve over a 90% acceptance rate. It's just amazing! ”

— **Martin F. Van Vliet, DMD**

Diplomate, American Board
of Orthodontics

Van Vliet Orthodontics
Highland, NY and Ramsey, NJ

Extended field-of-view



Reveal hidden impactions not seen on a pan

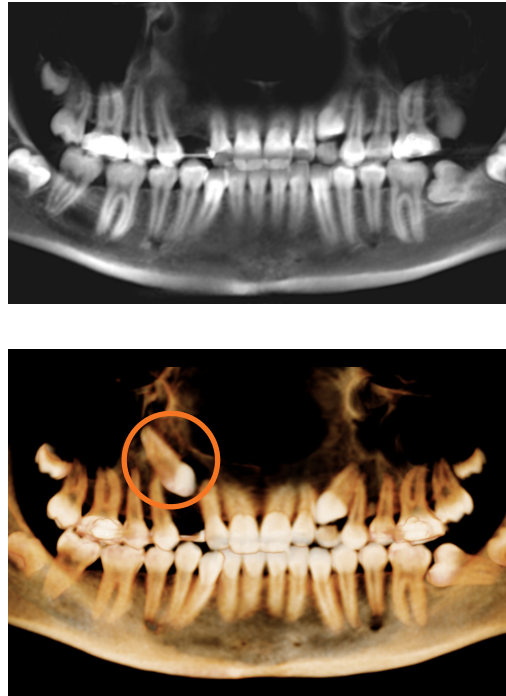

Supernumerary with a full crown



“ A 3D scan allows orthodontists to view the greater craniofacial complex, with airways, bone, sinus and TMJ health as a cohesive part of an integrated system. During treatment planning, I look at airways and sinuses first, then TMJs, then skeletal relationships, then alveolar housing, and lastly, the teeth. Although this has always been considered vital anatomy, 3D diagnosis and treatment planning give me a more precise view to catch the clues to unusual dental conditions. ”

– Juan-Carlos Quintero, DDS, MS

Quintero Orthodontics
South Miami, FL

“ There are a few pivotal decisions you will make during your orthodontic career, and buying an i-CAT will be one of them. Your confidence in treatment planning and case presentation will make you the expert in your area on anything 3D. There are a few new areas that I find I am starting to use my i-CAT for in treating the patient as a whole. Airway, sleep apnea, and TMJ are just a few of the areas. The amount of information at my fingertips is remarkable. The cool part of being a member of the i-CAT family is innovation, education, and support. i-CAT is continually trying to push the envelope at lower radiation doses and better quality images. They host 3D forums to help educate and support their customers. ”

– Stuart Frost, DDS, MS

Frost Orthodontics
Mesa, AZ

View bone, teeth, and facial profile with face-MATCH

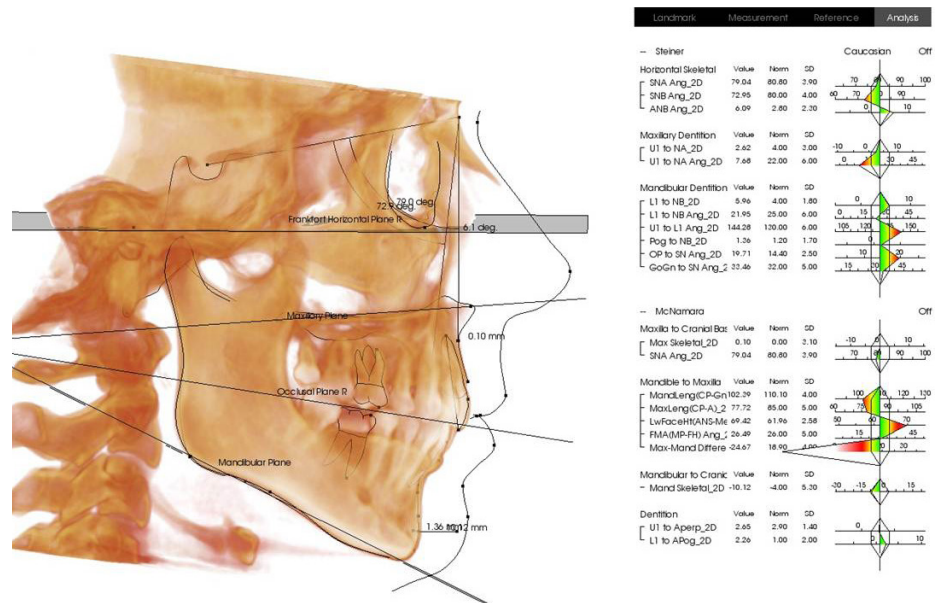
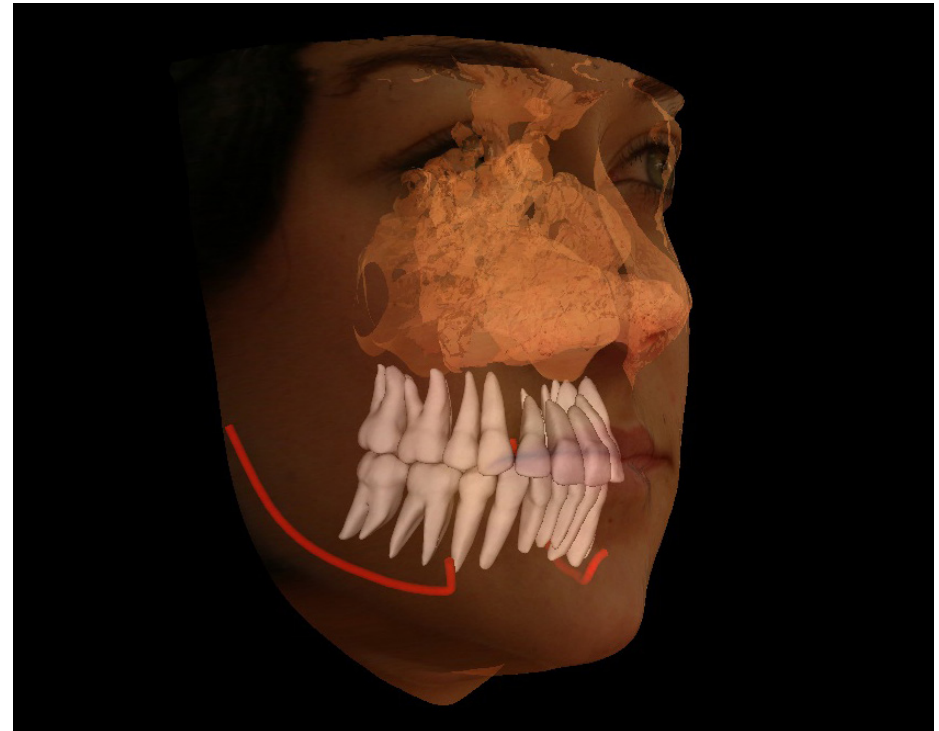

Fully featured tools for ceph analysis

Volumetric airway analysis

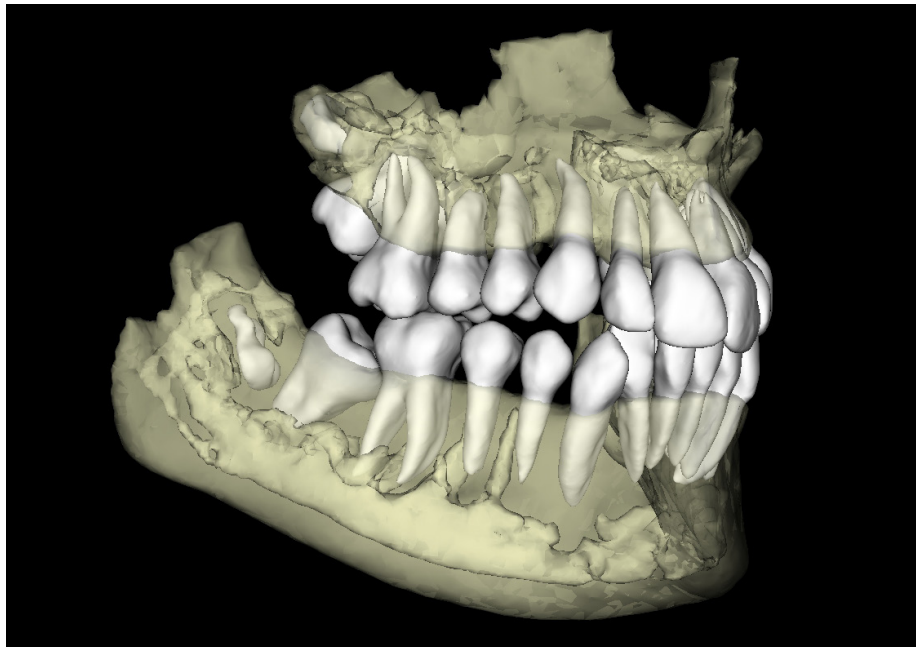
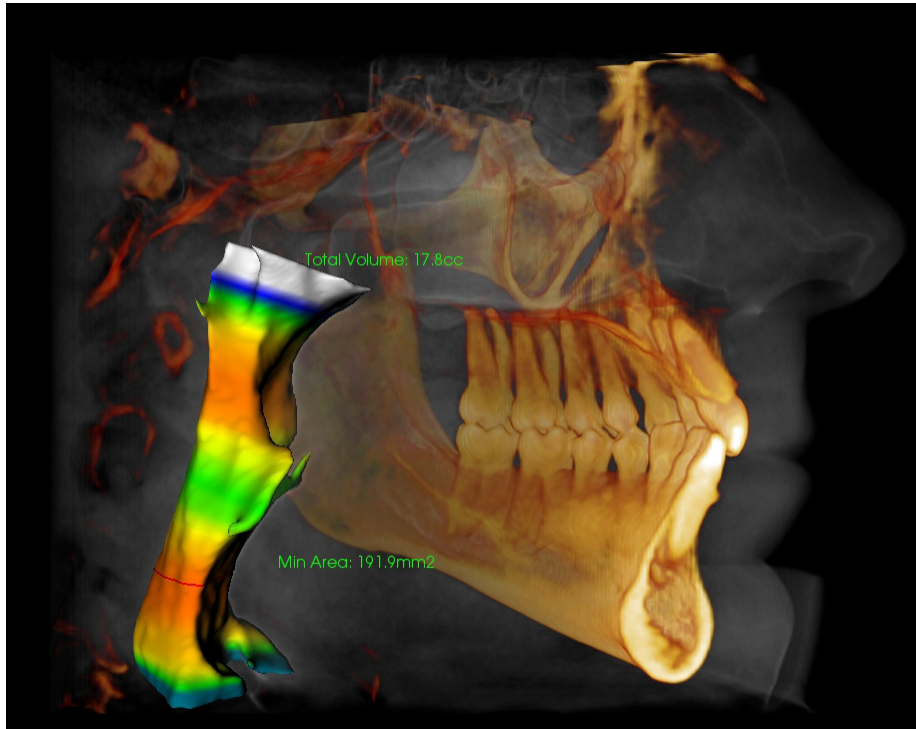

Segment out bone and/or teeth with AnatoModel

“ The i-CAT FLX helps me provide the best for my patients through its “game-changing” technology that allows me to take one 4.8-second low-dose scan with the QuickScan+ setting and obtain the 3D image for less radiation than with either a digital pan or ceph. There was once a time when 3D X-rays were considered by many in the profession to be too much radiation for the amount of information generated. But that time is no longer, thanks to i-CAT’s R&D team who are driven to continue to make a difference on this front. ”

– Jeffrey T. Kozlowski, DDS

Kozlowski Orthodontics
New London and East Lyme, CT

“ There aren't many things in orthodontics that actually make you a better orthodontist. My i-CAT FLX is one of the few exceptions. The i-CAT FLX allows me to visualize with stunning clarity my patient's current anatomic reality at radiation doses lower than what I was delivering with my 2D pan/ceph records. I'm now making clinical decisions that allow me to navigate anatomy in three dimensions. I used to make decisions based upon a two-dimensional representation of complex bone and root relationships. I now shudder at the very thought of that. Am I a better orthodontist now? Without a doubt. ”

– John Graham, DDS, MD

Sugarhouse Orthodontics
Salt Lake City, UT

IMPLANTS



Place and Restore with Accuracy and Confidence

Treat patients with greater surgical predictability and confident outcomes using i-CAT's 3D treatment planning tools.

Use i-CAT's high resolution, volumetric images, and complete 3D views for a more thorough analysis of bone structure and tooth orientation.

Collect precise data, and map an entire course of treatment for surgical placement of the implant and abutment, all the way to final restoration.

*Order surgical guides from a full implant library through Anatomage service and have them delivered to you in **under a week.***



“ I’ve been involved with CT scans in implant dentistry for over 25 years, and I’ve found that the new i-CAT FLX cone beam unit has now changed the way I practice implant dentistry. The i-CAT scanners produce unparalleled images that are so crucial in the treatment planning of dental implants. Additionally, the flexibility of these units allows the clinician to collimate and select various fields-of-view, thus drastically reducing the radiation exposure to the patient. ”

– **Randolph Resnik, DMD, MDS**

Director, Misch International
Implant Institute

Resnik Dental Implants
Pittsburgh, PA

Custom Abutment

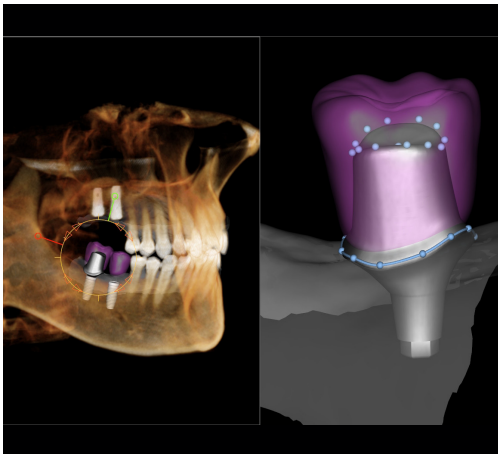

Maxillary implant placement

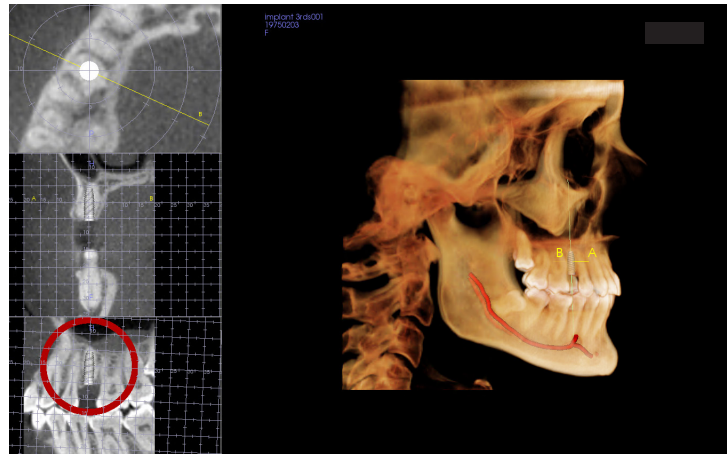

Visualize implants within the bone

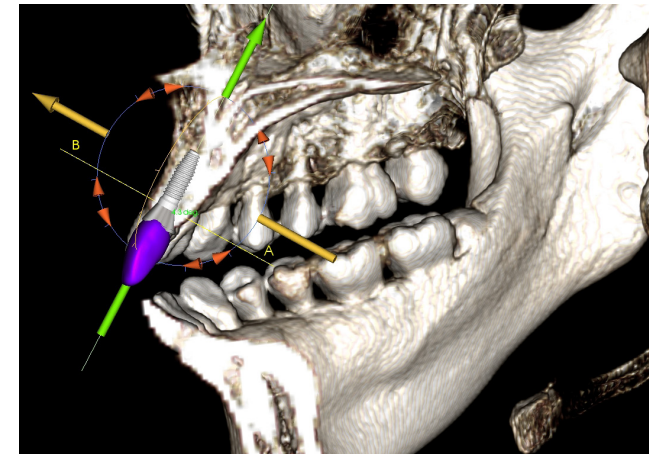

ORAL & MAXILLOFACIAL SURGERY



Map Surgical Treatment Plans

Tx STUDIO treatment planning software can assist you in identifying deformities, such as cysts, tumors, lesions, and changes of the jaw, to avoid potential surgical complications.

Determine precise position of impacted teeth within the alveolar bone, as well as their proximity to adjacent teeth and vital structures, such as the nerve canal, sinus walls, and cortical borders.

“ With the i-CAT FLX in particular, I can capture quick, lower-dose exposures as needed. The system also has a QuickScan+ setting that allows for a full-dentition 3D scan at a comparable dose to a 2D panoramic image*. I can now take a follow-up scan for cases where reevaluation is critical and gain much more information than a pan offers. This allows for better monitoring – with significantly less radiation – during the healing process, and for early intervention, when indicated, for optimal long-term prognosis. ”

– Daniel C. Cullum, DDS

Diplomate, American Board of Oral
and Maxillofacial Surgery

Implants Northwest
Coeur d'Alene, ID

Cross-sectional views help identify impacted tooth position relation to other teeth and roots, as well as pathology prior to 3rd molar extractions

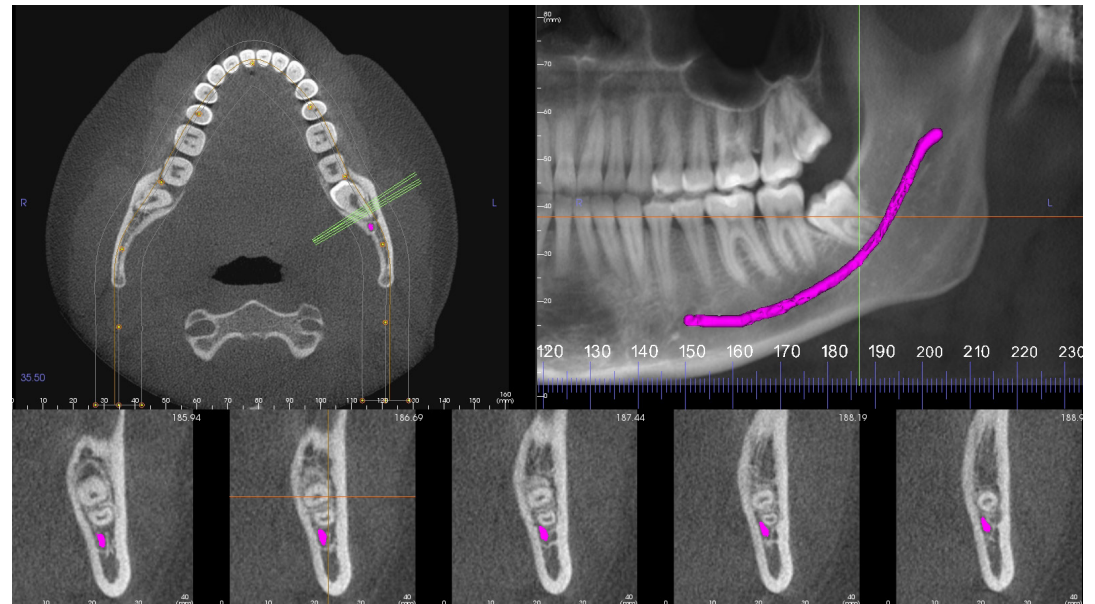
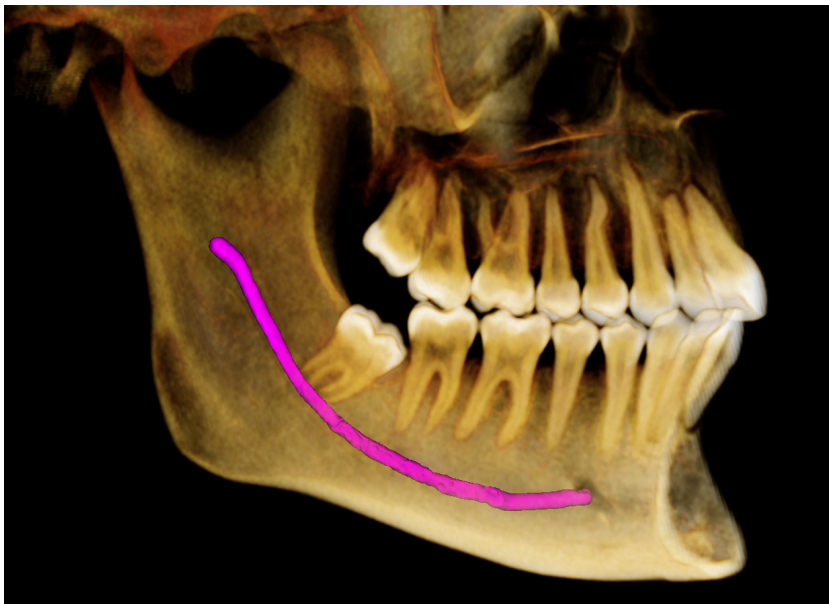

AIRWAY ANALYSIS

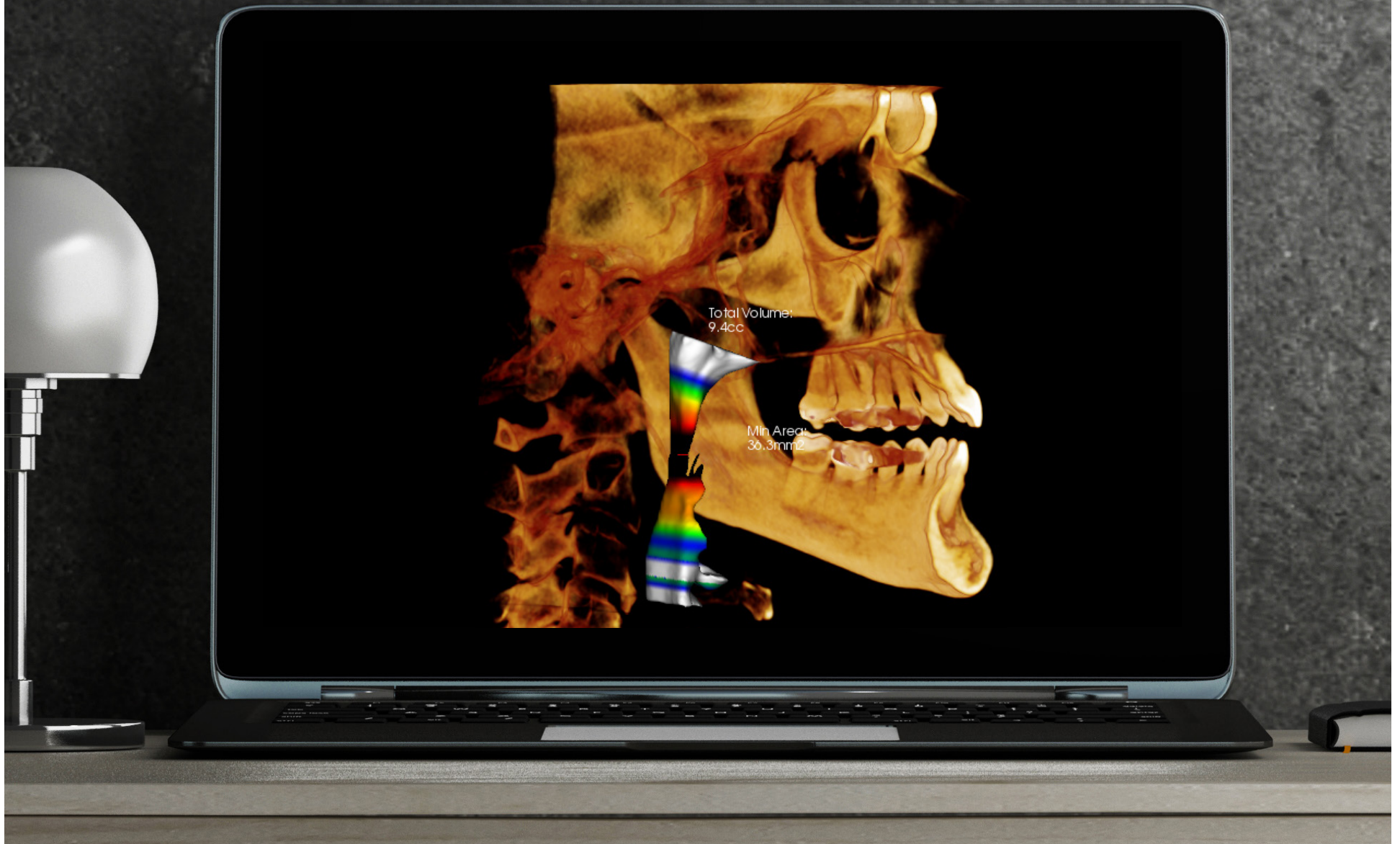

Evaluate for Airway Obstructions to Help Identify Patients with an Increased Risk of a Possible Sleep Disorder

For patients with suspect airway or sinus tissue, you can use i-CAT scans in software such as Tx STUDIO to review the 3D data and reveal compromised airways – which can be an indication of a sleep disorder.

Assess airway volume at-a-glance using color-coded constriction values. Quickly trace airways on-screen to perform automatic calculations and measurements of paranasal sinuses to evaluate treatment options.

Additionally, scanning patients while wearing oral appliances can show the effectiveness of the device through changes in airway volume.

“ In my business, I have to figure out why people hurt and don't breathe. Since orthopedic disorders of the TMJs and facial pain are often the result of breathing disorders, volumetric evaluation of the nasal, nasopharyngeal, velopharynx and hypopharynx are absolute. My i-CAT reliably gives me this vital information with the lowest radiation dose possible. In fact, the i-CAT FLX does it so much easier with a fraction of the radiation. ”

– **Steven R. Olmos, DDS**

Founder, TMJ & Sleep Therapy
Centre International, LLC
La Mesa, CA

Soft and hard tissue shown in 3D rendering

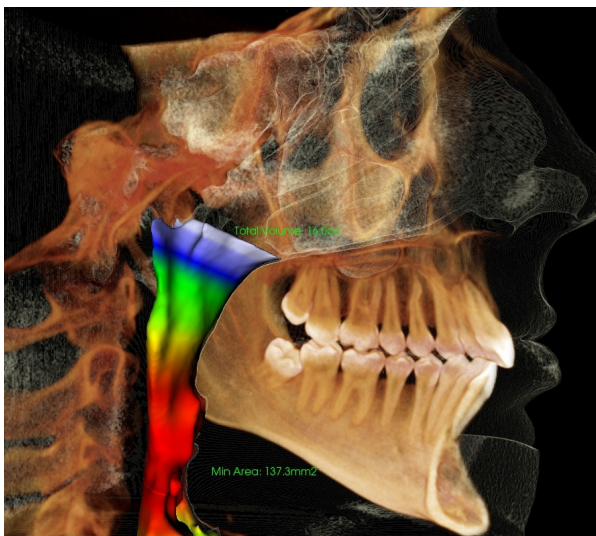

Isolated visual of airway

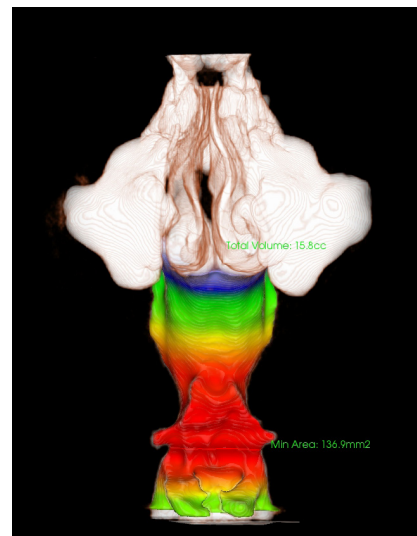

Efficiently survey full anatomy

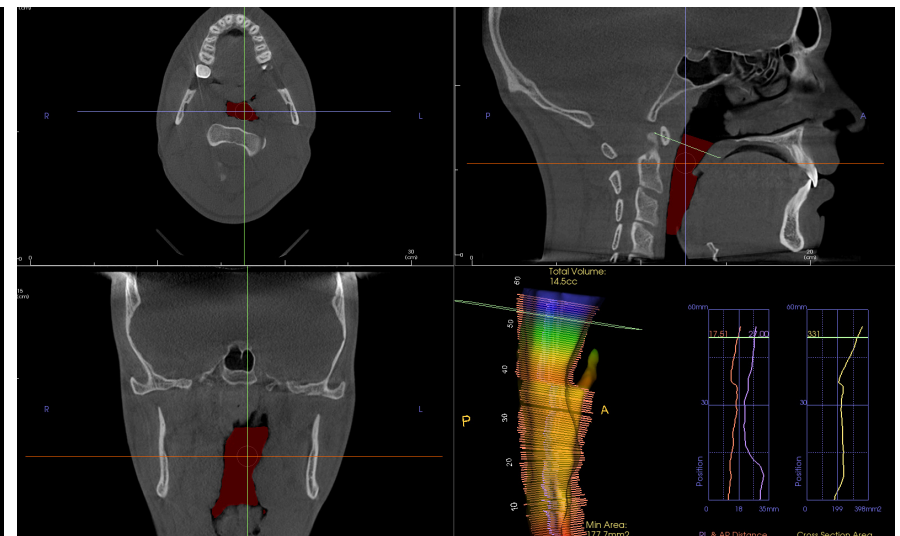

PERIODONTICS



Analyze Bone Structure

From implant placement to surgical options for the management of bone loss, the i-CAT FLX V-Series provides periodontists with the wide range of services expected from the specialty. Capture 3D volumetric images for a more thorough analysis of bone structure as well as sinus and nerve location.

i-CAT FLX V-Series imaging systems provide scan options and a full complement of tools for implant placement. Use scan data to help plan the course of treatment of bony defects prior to the actual osseous surgery appointment. With Tx STUDIO software's highly visual 3D presentation, share your diagnosis and plan with the patient for greater understanding leading to better post-treatment compliance.

“ Having an i-CAT increases safety for my patients and confidence for me. The information provided by the CBCT scan allows the practitioner to recognize anatomical conditions that would be otherwise undetectable on 2D radiographs. I can now do virtual implant placement, and I don't have to guess on nerve location. All of the details that 3D offers ensure long-lasting positive treatment outcomes. ”

– **John Russo, DMD, MHS**

Diplomate of the International
Congress of Oral Implantologists
Sarasota, FL

Comprehensive scan data and software tools for implant planning

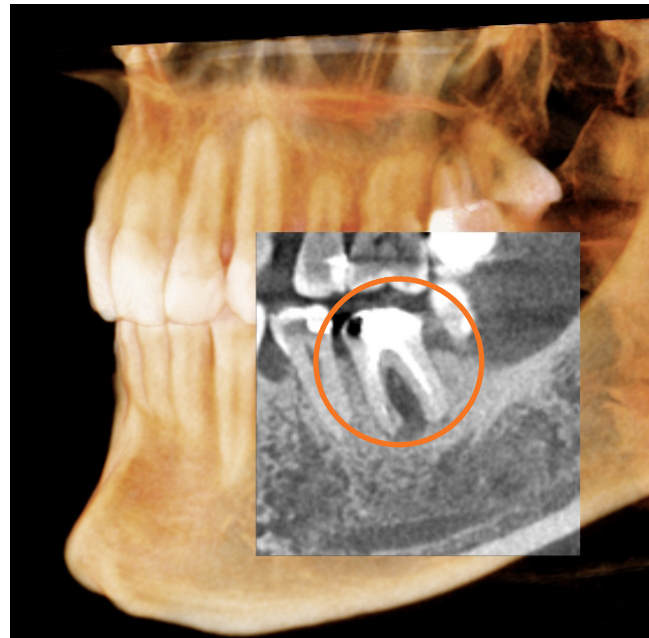

The complete picture of bony defects



ENDODONTICS



Survey Roots in Three Dimensions

When more concentrated studies are necessary, high resolution scans — up to .125 mm voxels — lend more detail for the identification of lesions. Scans can also be collimated to cover the area of interest.

Within Tx STUDIO software, scans can be explored axially and buccolingually for a complete survey of fractures, accessory canals, and endo-perio involvement.

Review hard to visualize accessory canals with high resolution axial views



Discover root fractures using cross-sectional views



3D view of destruction from endodontic lesions

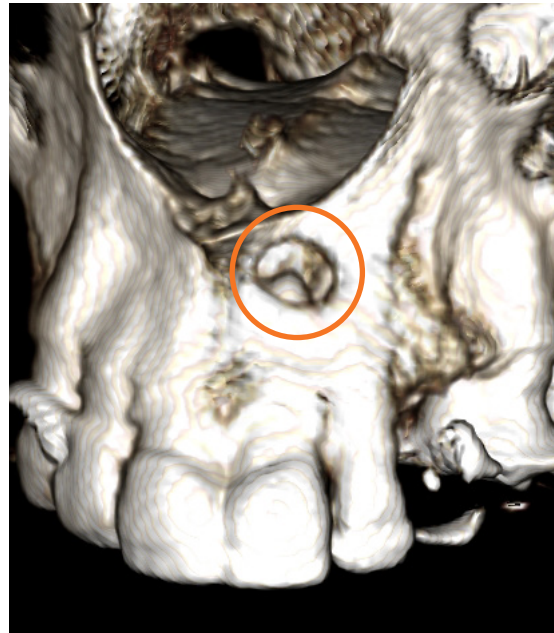

Use multiple viewing capabilities to discover lesions and pathology

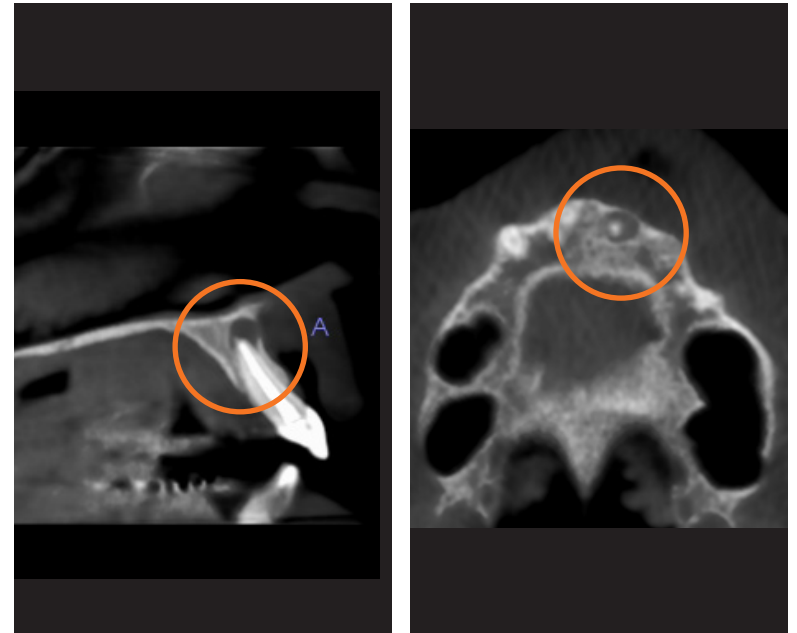

TMJ



Detect TMD and Assess Fractures

Detect TMJ anomalies for the ability to design effective patient treatment. Using the TMJ visualization tools, zero in on the temporomandibular joints to identify wear, defects, and fractures. These tools also act as virtual study models to streamline and expedite treatment, and allow you to design splints with the optional Medical Design Studio module.

“ The i-CAT CBCT allows me to acquire and interpret remarkable views of the TMJs quickly, efficiently, and with low radiation dosages for the patient. The patient does not have to leave the office, and we can provide the patient with nearly instant feedback. ”

– Steven A. Guttenberg, DMD, MD

Diplomate, American Board of
Oral and Maxillofacial Surgery
Washington, DC

Multiple views of TMJ offer greater visualization

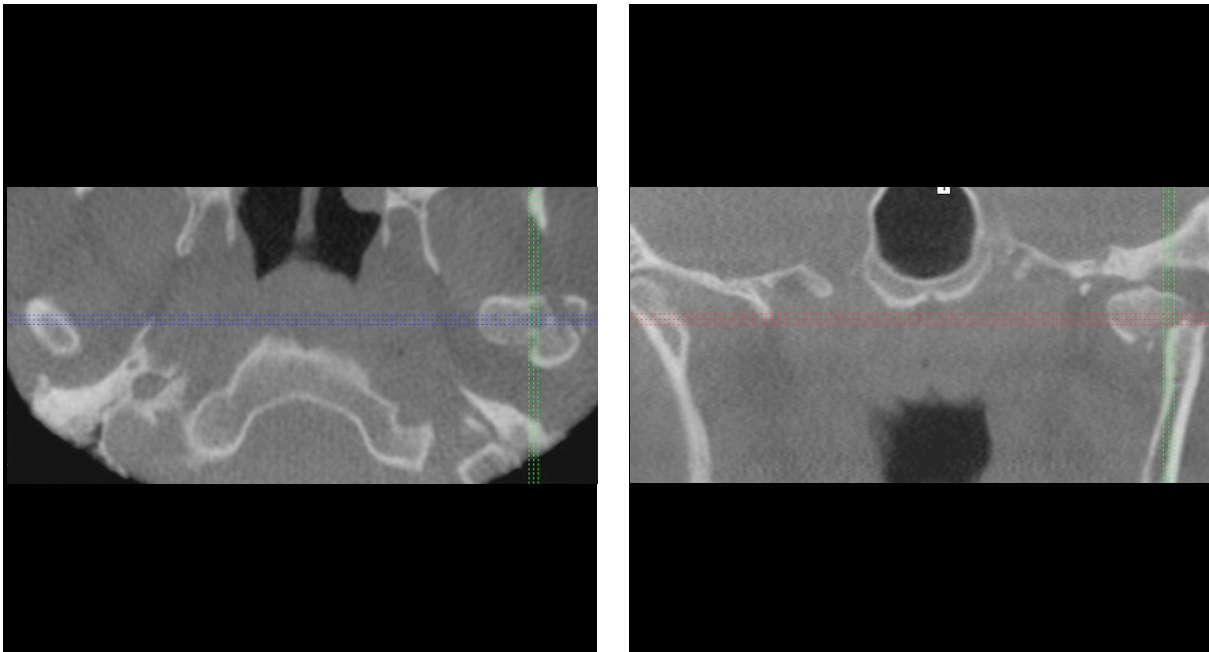

3D rendering of scan yields details of trauma



i-CAT™ FLX

V - S E R I E S

The i-CAT FLX V-Series Provides Balance Between Image Quality and Dose

The i-CAT FLX V-Series imaging solutions put the power of precision in your hands, simply and conveniently. Dental clinicians now have direct access to advanced 3D treatment tools for implants and restorations, oral and maxillofacial surgery, TMJ and sinuses, and orthodontics. Consistently impressive image quality is delivered through proprietary tools that create high definition, low dose scans quickly and easily every time.

i-CAT quality in a model that fits your practice



V8

V10

V17

Field-of-View

Now more than ever, practitioners have the flexibility of selecting the CBCT solution that best fits their practice needs. The i-CAT FLX V-Series has 3 solutions based on field-of-view to best support the needs of your practice. What makes the V-Series unique is the ability to easily upgrade the field-of-view options as your practice grows.

i-CAT™ FLX	V8	V10	V17
 FOV 8cm x 5cm	✓	✓	✓
 FOV 8cm x 8cm	✓	✓	✓
 FOV 16cm x 4cm	Available with upgrade	✓	✓
 FOV 16cm x 6cm	Available with upgrade	✓	✓
 FOV 16cm x 8cm	Available with upgrade	✓	✓
 FOV 16cm x 10cm	Available with upgrade	✓	✓
 FOV 16cm x 11cm	Available with upgrade	Available with upgrade	✓
 FOV 16cm x 13cm	Available with upgrade	Available with upgrade	✓
 FOV 23cm x 17cm	Available with upgrade	Available with upgrade	✓
DEDICATED 2D PAN	✓	✓	✓

i-CAT™ FLX

V - S E R I E S

i-CAT FLX SPECIFICATIONS

Sensor Type	Amorphous Silicon Flat Panel Sensor with CsI Scintillator
Grayscale Resolution	16-bit
Voxel Size	.4 mm, .3 mm, .25 mm, .2 mm, .125 mm
Collimation	Electronically controlled fully adjustable collimation
Scan Time	4.8, 8.9, 14.7, 17.8 or 26.9 seconds
Exposure Type	Pulsed
Field-of-View	V8: 8cm x 5cm, 8cm x 8cm V10: 8cm x 5cm, 8cm x 8cm, 16cm x 4cm, 16cm x 6cm, 16cm x 8cm, 16cm x 10cm V17: 8cm x 5cm, 8cm x 8cm, 16cm x 4cm, 16cm x 6cm, 16cm x 8cm, 16cm x 10cm, 16cm x 11cm, 16cm x 13cm, 23cm x 17cm
Reconstruction Shape	Cylinder
Typical Reconstruction Time	Less than 30 seconds
Viewing and Treatment Software	Included
DICOM Compatible	Yes
Unit Size	48" (w) x 69.5" (h) x 36.37" (d)
Patient Position	Seated
Wheelchair Accessible	Yes

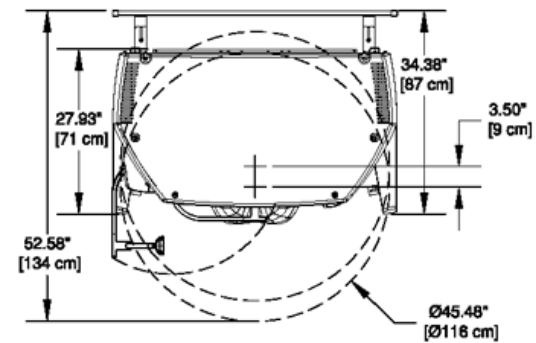
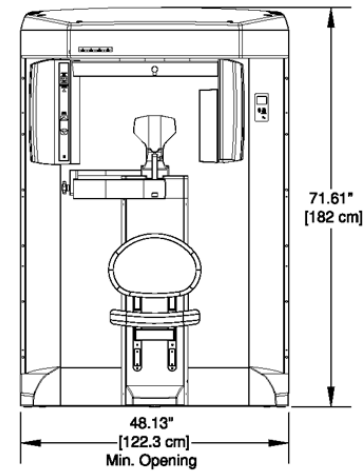

*Utilizing the i-CAT FLX QuickScan+ exposure protocol. Use of lower dosage imaging may only be suitable for certain diagnostic tasks. Image quality is proportional to dose. i-CAT FLX offers a variety of exposure protocols allowing clinicians to adjust dosage to specific diagnostic needs.

¹X-ray images acquired using i-CAT can be analyzed within Tx STUDIO for treatment planning.
NOTE: All clinical images shown are created from scans utilizing i-CAT technology.

i-CAT UNIVERSITY

The i-CAT University is a unique entity of its kind dedicated to the ongoing education of dentists and specialists to enhance planning and treatment through the latest in cone beam technology. Our network of educators includes highly regarded leaders in specialty fields who have extensive i-CAT experience. This industry-leading educational program is the first to collaborate with Board-Certified Oral and Maxillofacial Radiologists to design and deliver a curriculum on cone beam imaging by dentists for dentists.

Commitment to continuing education for customers is reflected in the extensive programs offered pre- and post-installation, including online tutorials, webinars, regional classes, custom on-site training, Users' Meetings, and 3D Congress.

Learn more about our live and virtual education opportunities at i-CAT.com



3D CONGRESS
THE GLOBAL EVENT FOR DENTAL 3D IMAGING



WEBINARS, COURSES, TRAINING, AND MORE...

Visit i-CAT.com for the latest webinars, date and locations of upcoming CE courses, a training section to help walk you through any questions you may have.

i-CAT.com



JOIN THE CONVERSATION

Get exclusive updates on i-CAT happenings!

i-CAT™